

Hudson

BEARINGS

HDBT 1-3/16

Heavy Duty Ball Transfers



HDBT 1-3/16 CS

Additional ball materials available

Part Number	Housing Mat.	Ball Material	Load Cap.
HDBT 1-3/16 CS	Carbon Steel	Carbon Steel	550 lbs.
HDBT 1-3/16 CS/SS	Carbon Steel	Stainless Steel	550 lbs.
HDBT 1-3/16 SS	Stainless Steel	Stainless Steel	550 lbs.

550 LB. CAPACITY

- Integral flange at top allows unit to be dropped into 1-13/16" diameter hole.
- 1-3/16" Main ball rotates on 1/8" support balls.
- Carbon steel ball support cup is machined from solid steel and is hardened and plated.
- Available in stainless steel for additional corrosion resistance.

For 850 lbs. load capacity and additional material options, see our Air Cargo line card.

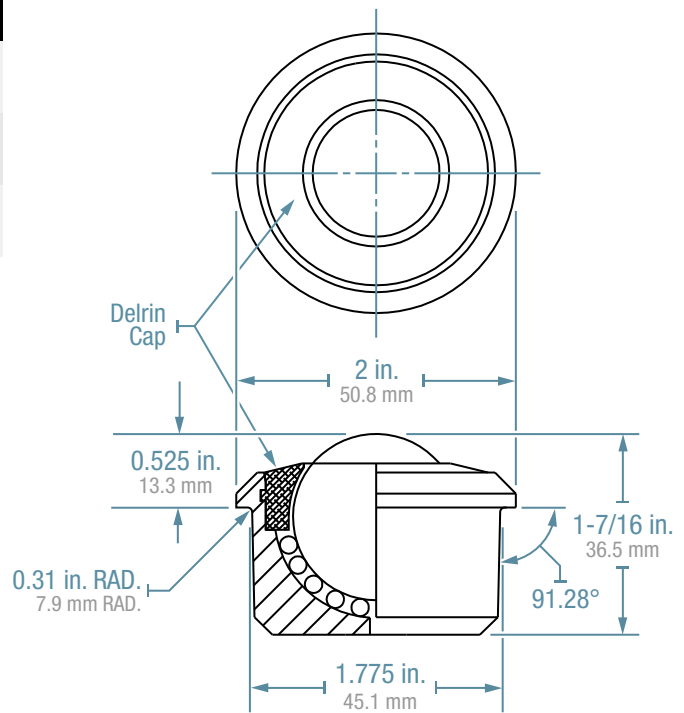

All product designs subject to change, please verify accuracy of dimensions.

PS1508